

CHAMBER 1200 X 600 X 700H

Aluminium Sika Chambers are lightweight, strong and durable. Delivered flat-pack for convenient transportation and engineered for rapid installation in challenging locations. Get the hole cost advantage.

Dimensions:	1200 X 600 X 700
Standard:	AS 3996-2006
Design Load:	Class D 210kN
Weight:	71kg
Heaviest Part:	20kg
Product Code:	D210-07-120607

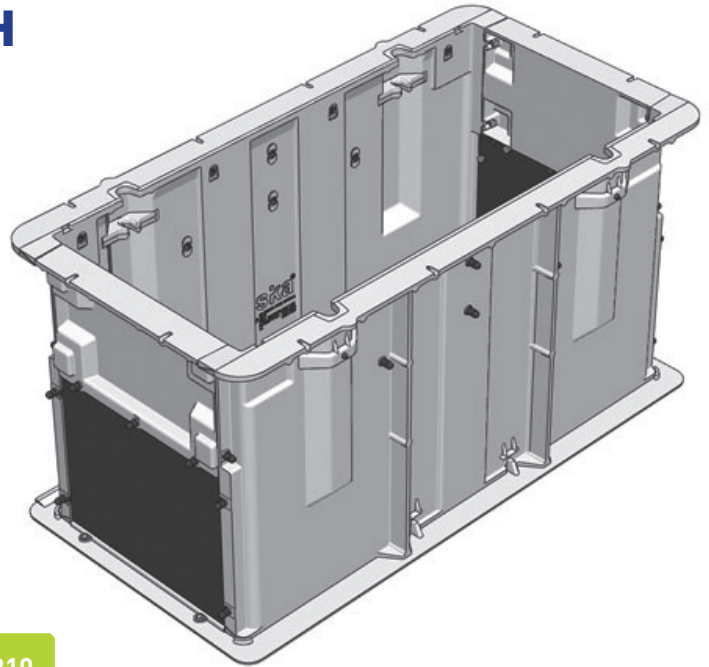

1200 LONG	600 WIDE	700 HIGH	71 KG	AS	CLASS D	210 kN
---------------------	--------------------	--------------------	-----------------	-----------	----------------	------------------

MAKE IT A PACKAGE

WITH SIKA COVER SETS

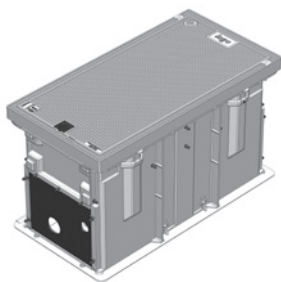
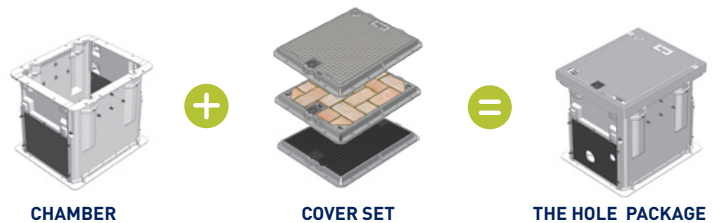

CLASS B CHAMBER AND COVER SET PACKAGE 1200 X 600 X 700H

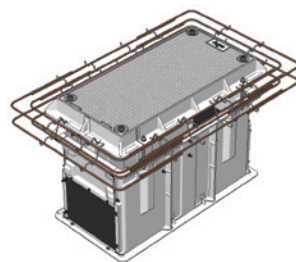

CLASS D CHAMBER AND COVER SET PACKAGE 1200 X 600 X 700H

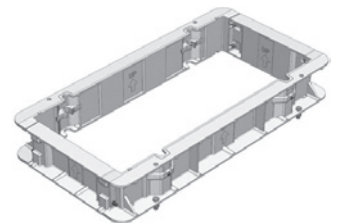

CHAMBER EXTENSION

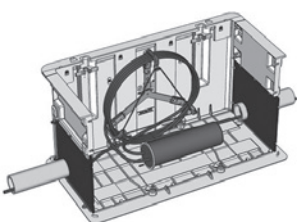

CABLE MANAGEMENT BRACKET

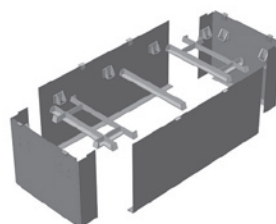

REUSABLE CHAMBER SHUTTERS

Visit our website for product details: sikatech.co.nz